

**Donkey, donkey, old and gray,  
Open your mouth and gently bray;  
Lift your ears and blow your horn,  
To wake the world this sleepy morn.**

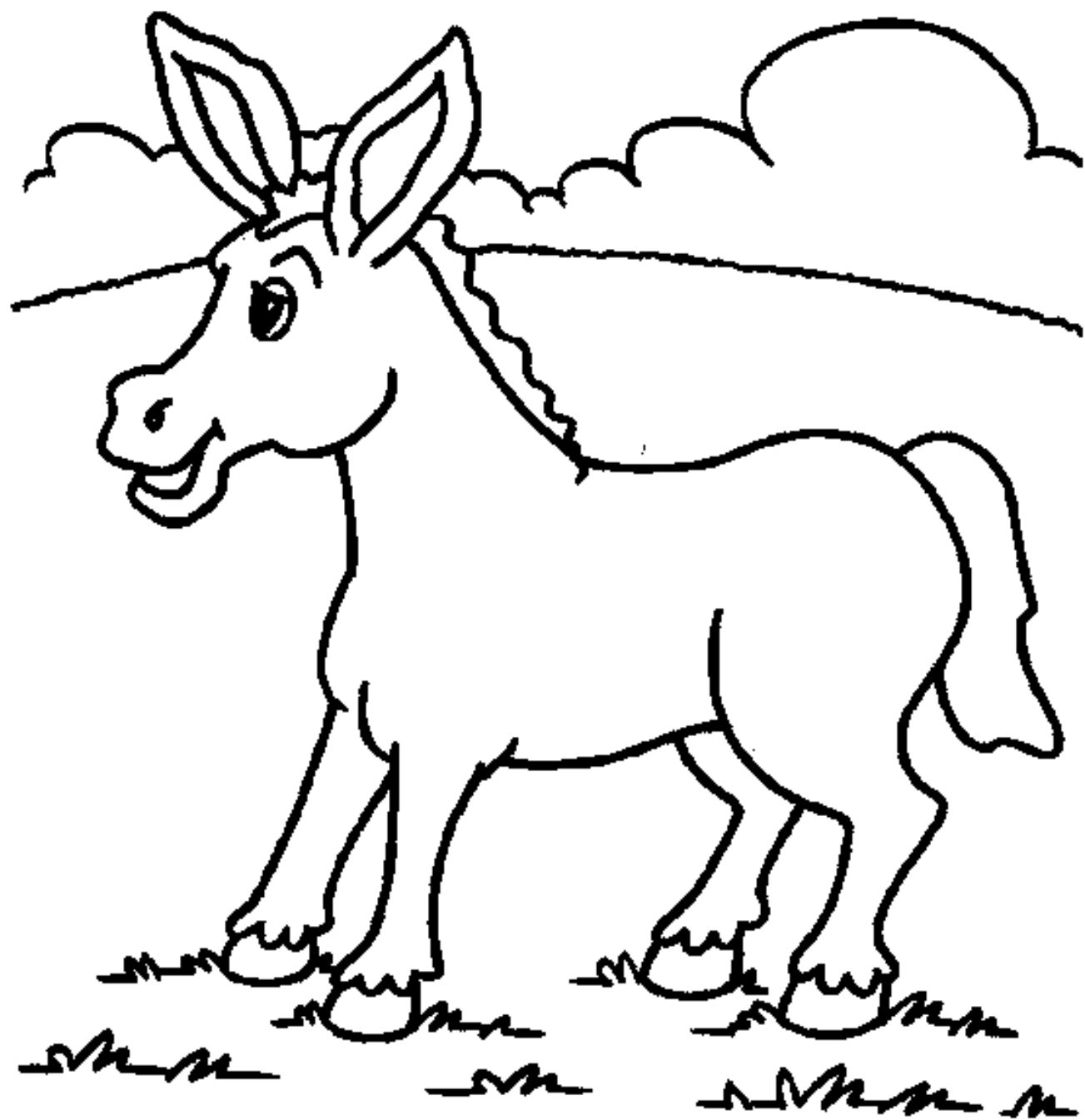

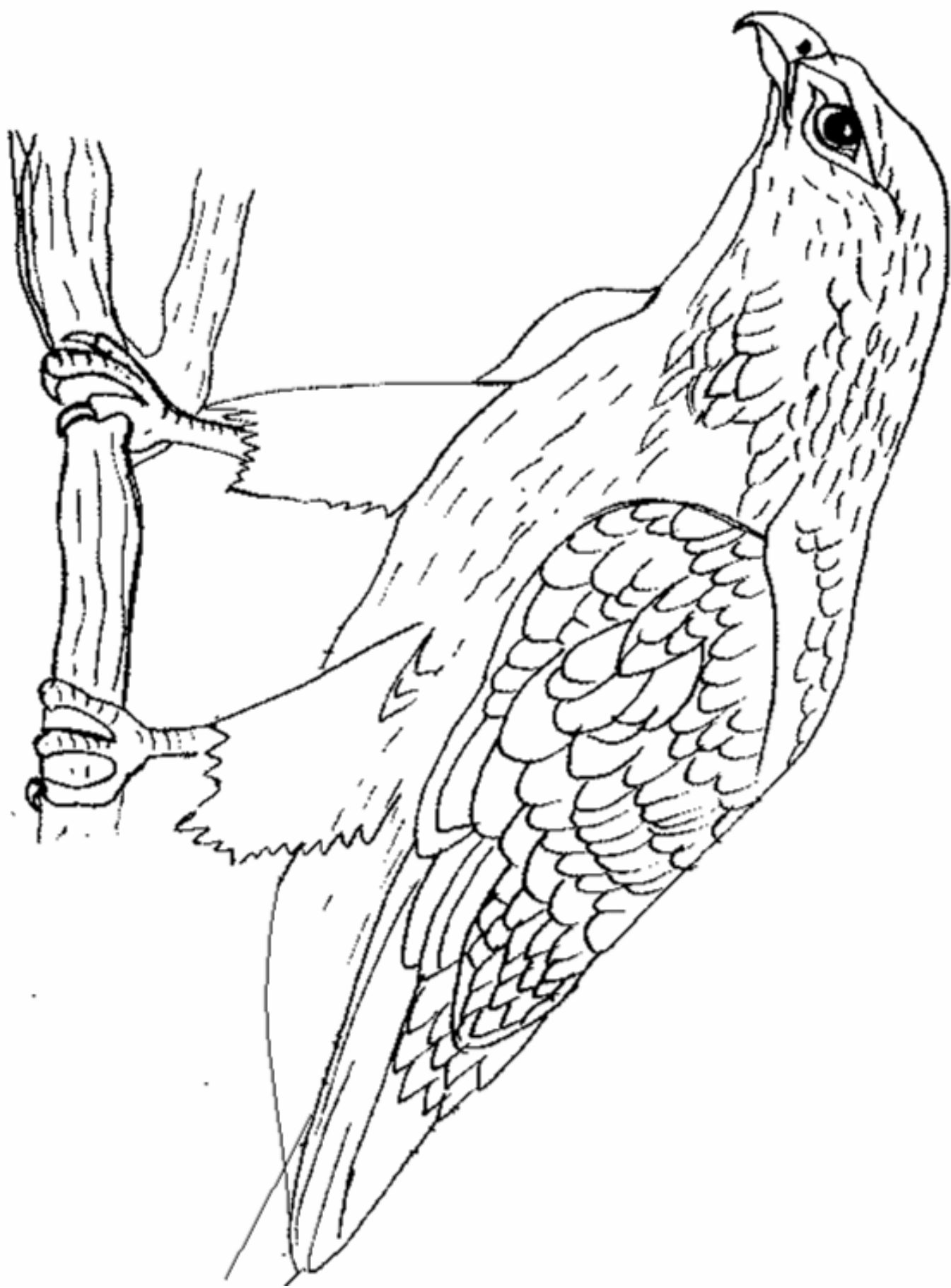

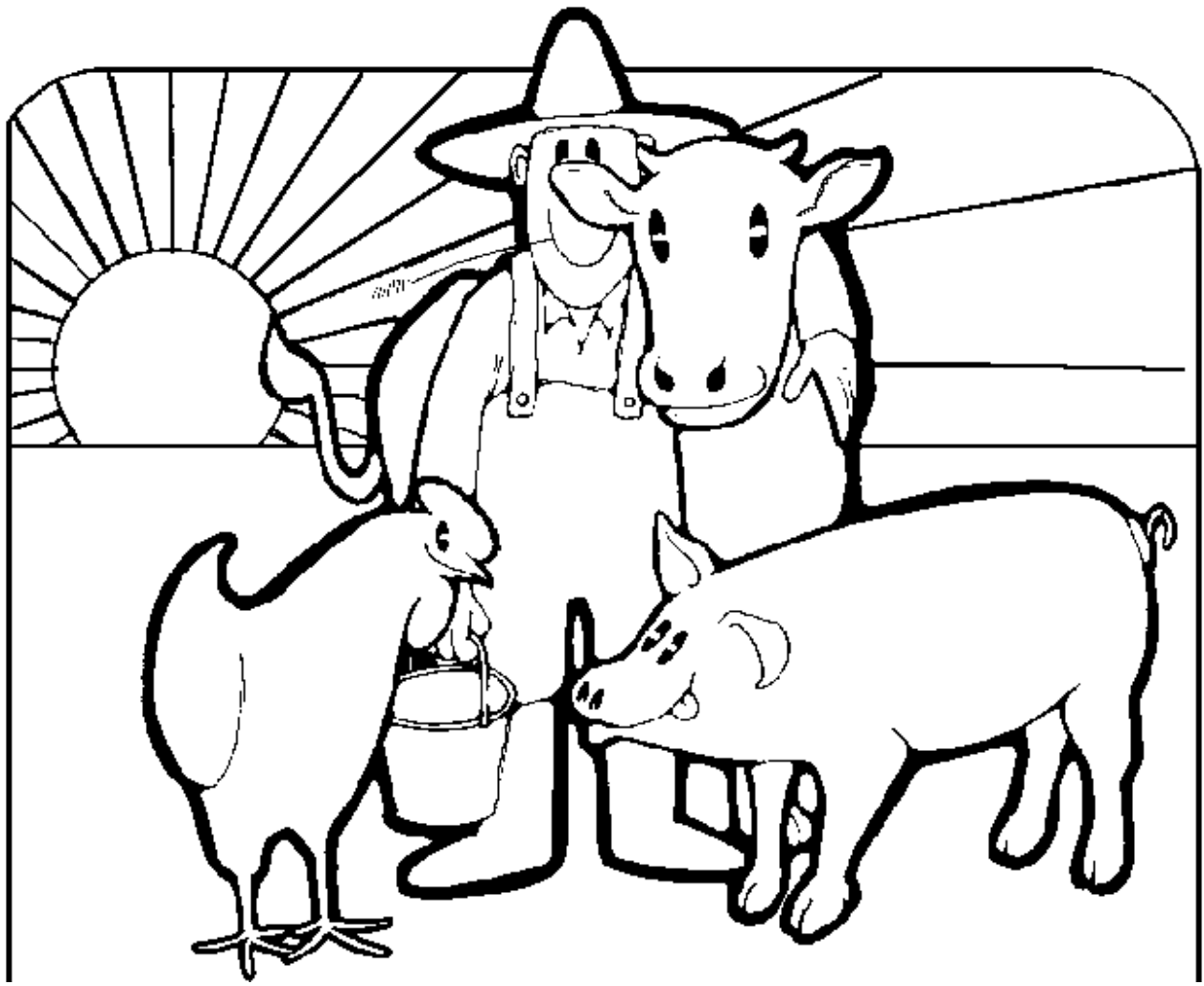





Name: .....

Date: .....

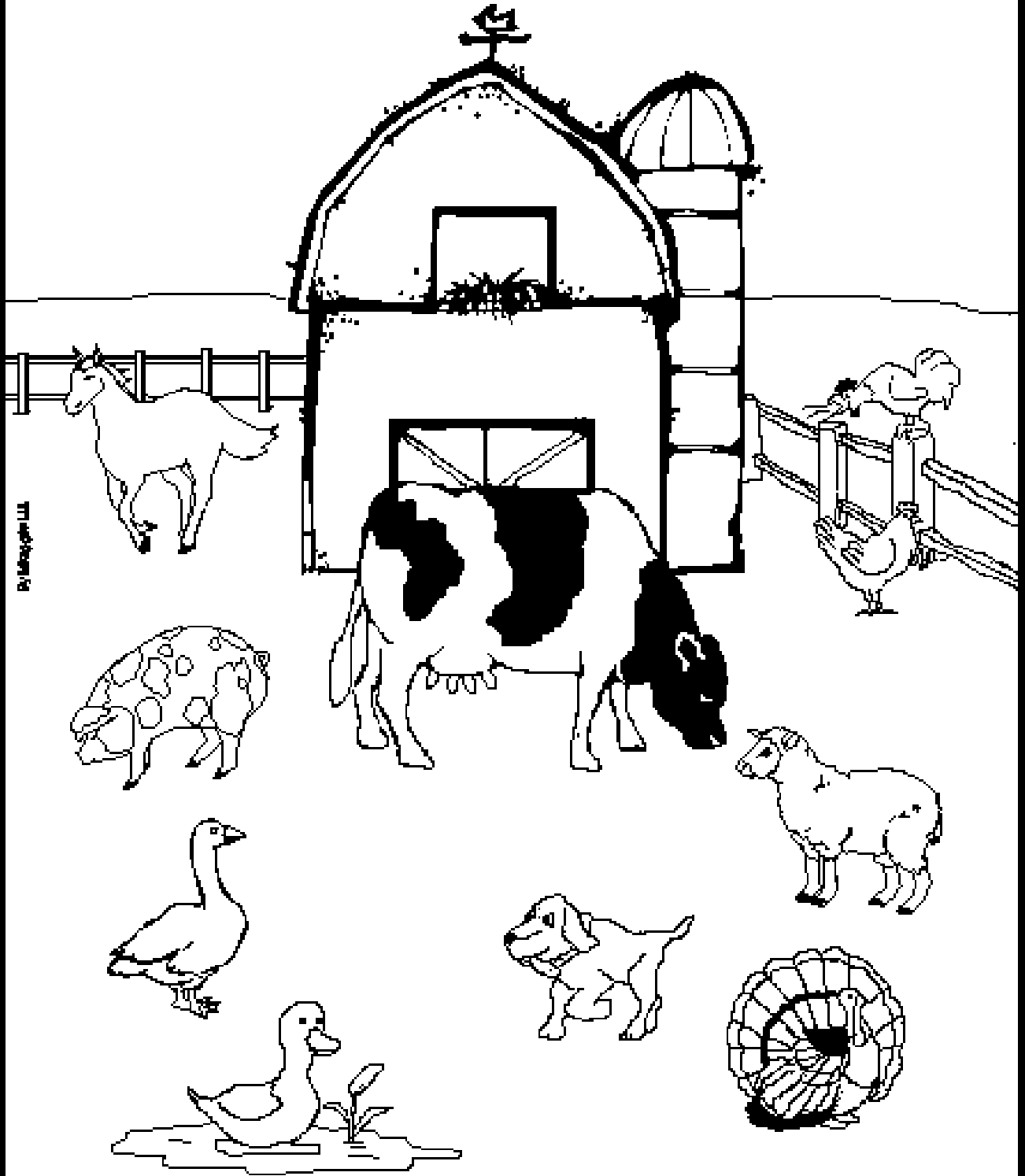

© 1999 by ABCmouse.com

Name : \_\_\_\_\_

Date : \_\_\_\_\_

Different animals produce different things. Fill in the blanks below the animals with the correct alphabet of the products it produces. You may write the name of the products too if you wish.

**a** stuffing for quilt and pillow

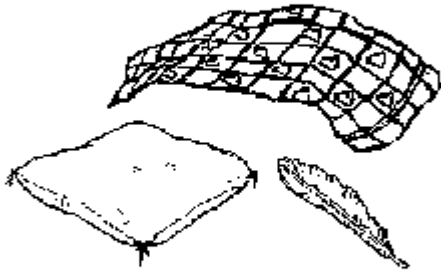

**b** milk



**c** clothes, mitts, wool



**d** eggs



**e** cheese



**f** leather bags, shoes

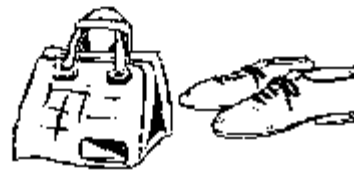

**g** meat



**h** butter

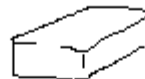

\_\_\_\_\_

\_\_\_\_\_



\_\_\_\_\_

\_\_\_\_\_



\_\_\_\_\_

\_\_\_\_\_



\_\_\_\_\_

\_\_\_\_\_



\_\_\_\_\_

\_\_\_\_\_



\_\_\_\_\_

\_\_\_\_\_

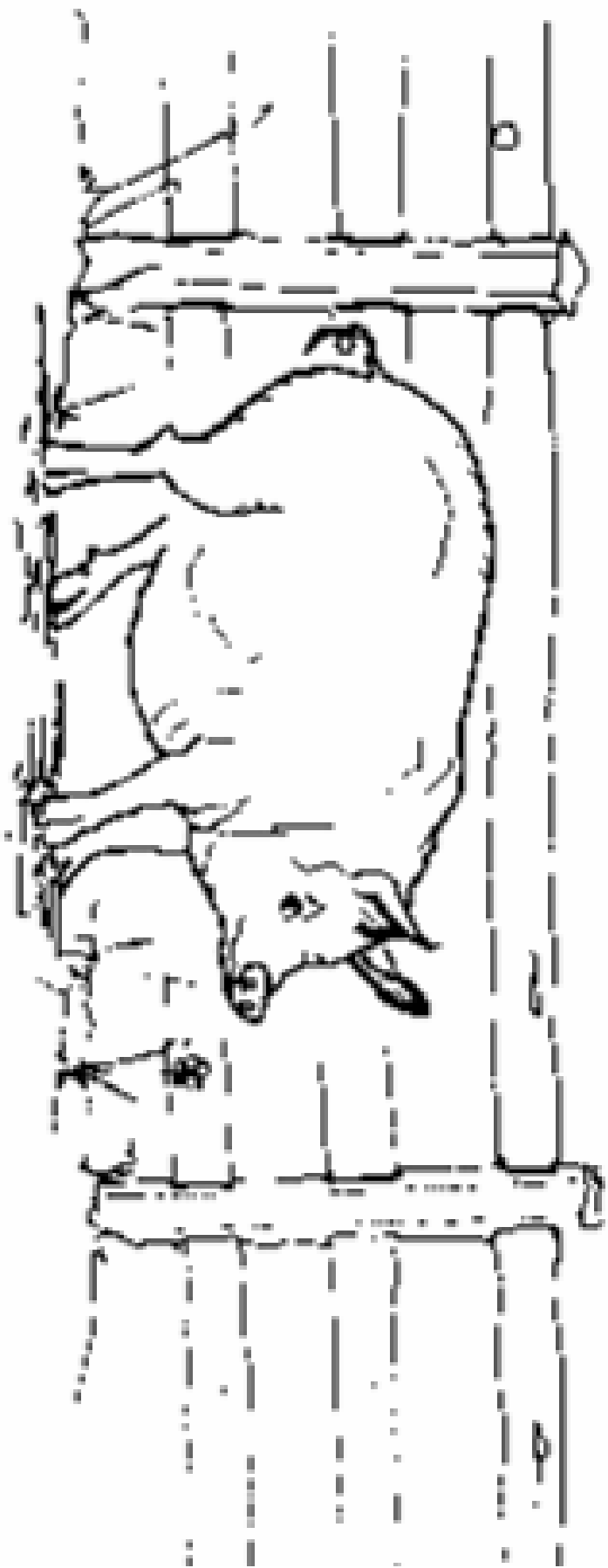





Handwritten text on the left side of the page, oriented vertically. The text is written in a cursive, somewhat illegible script. It appears to be a signature or a name, possibly starting with 'Sara' and ending with 'W'. There are some additional marks and lines around the text.





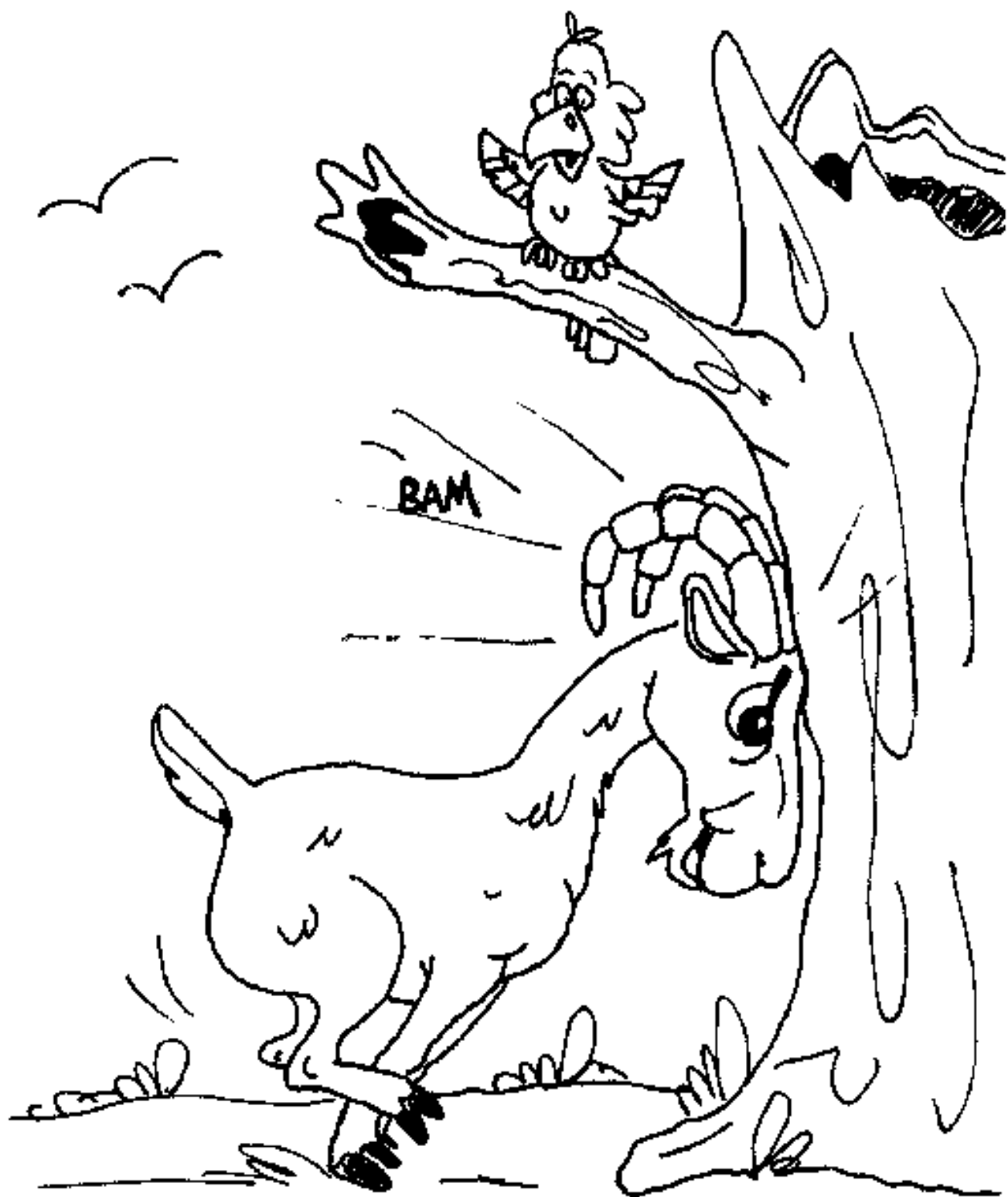

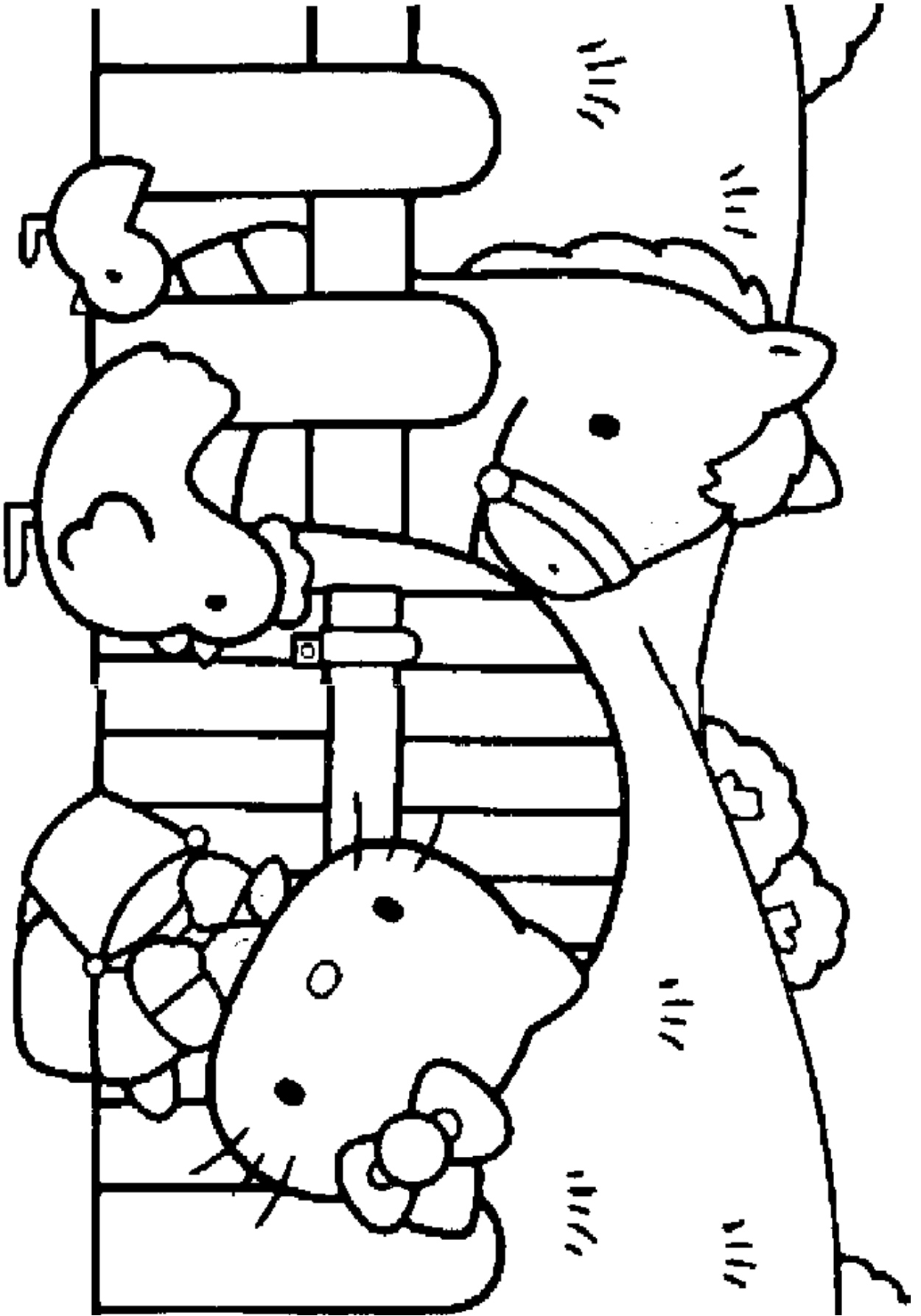

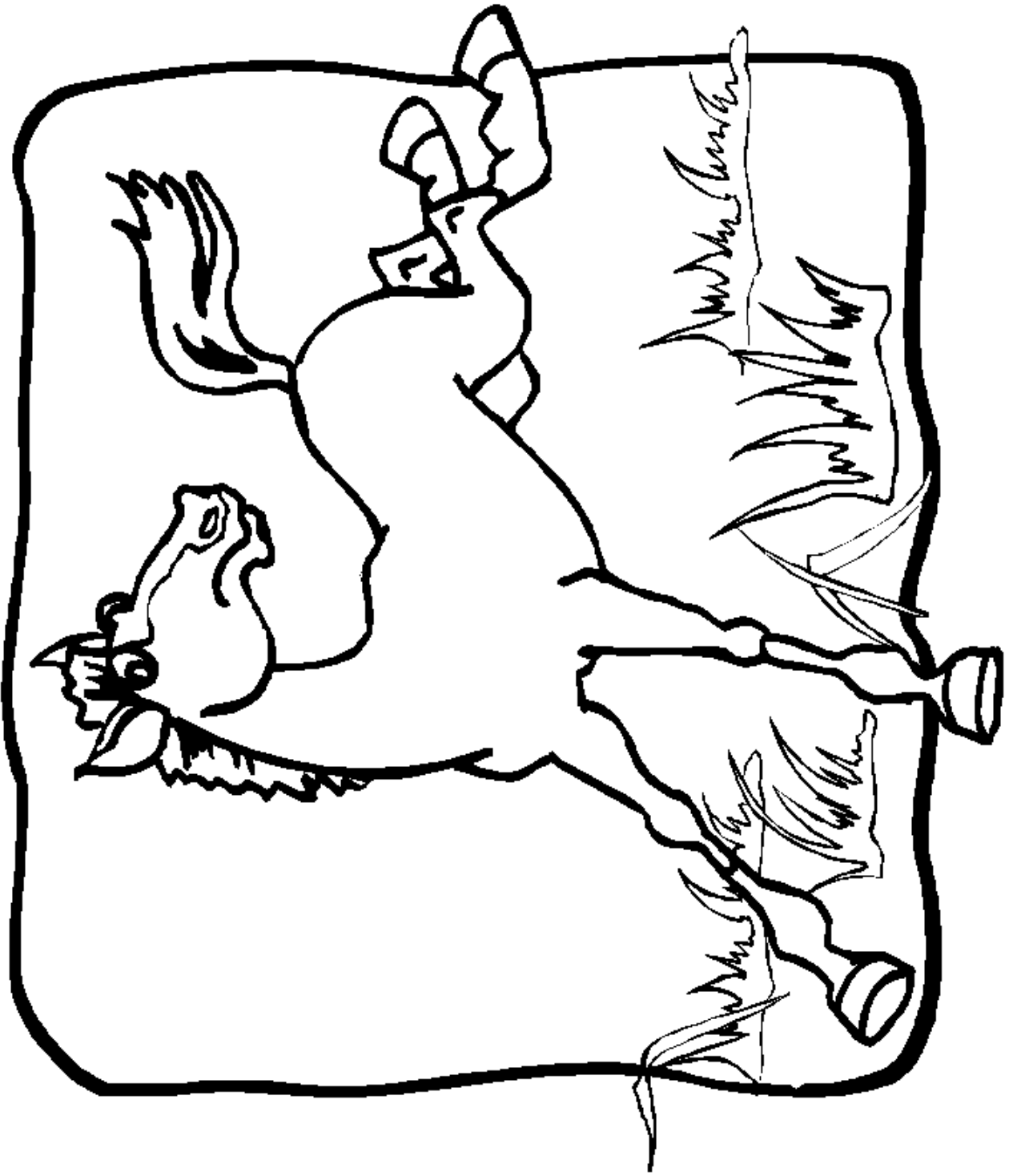

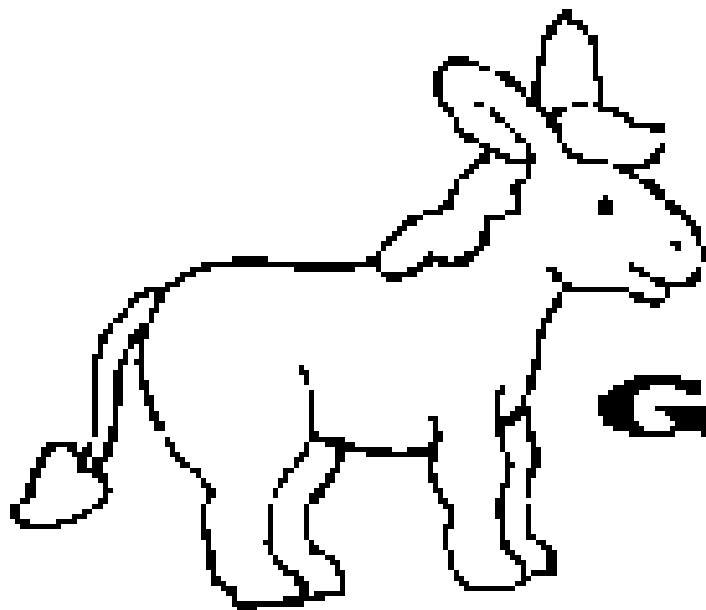

**GRUNTS**



**QUACKS**

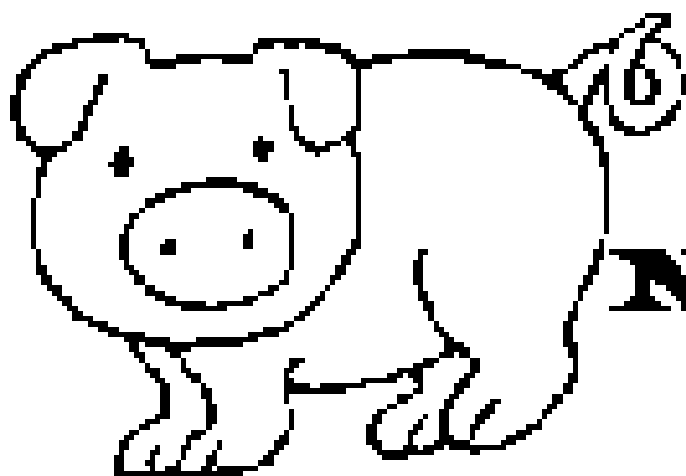

**NEIGHS**



**CACKLES**



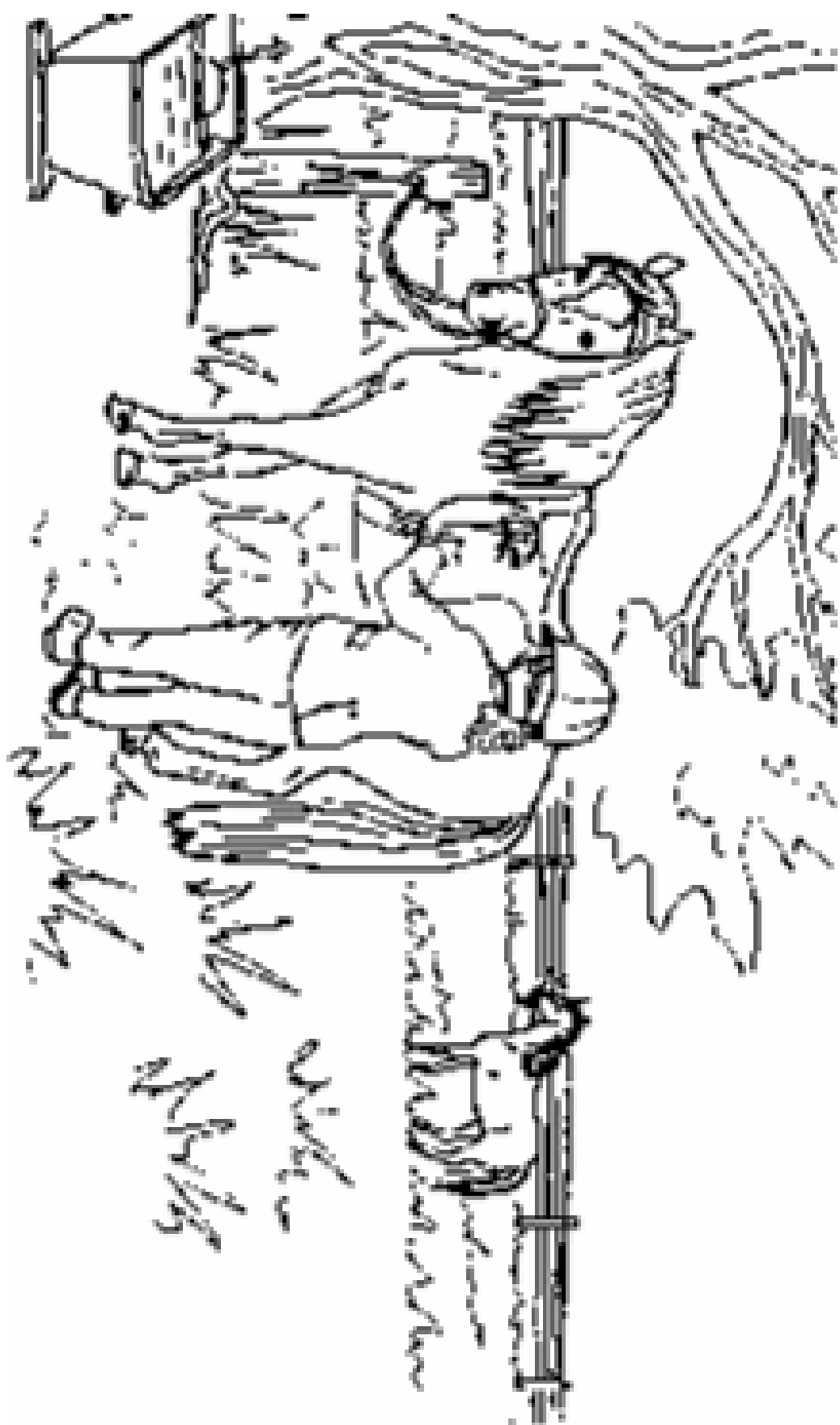

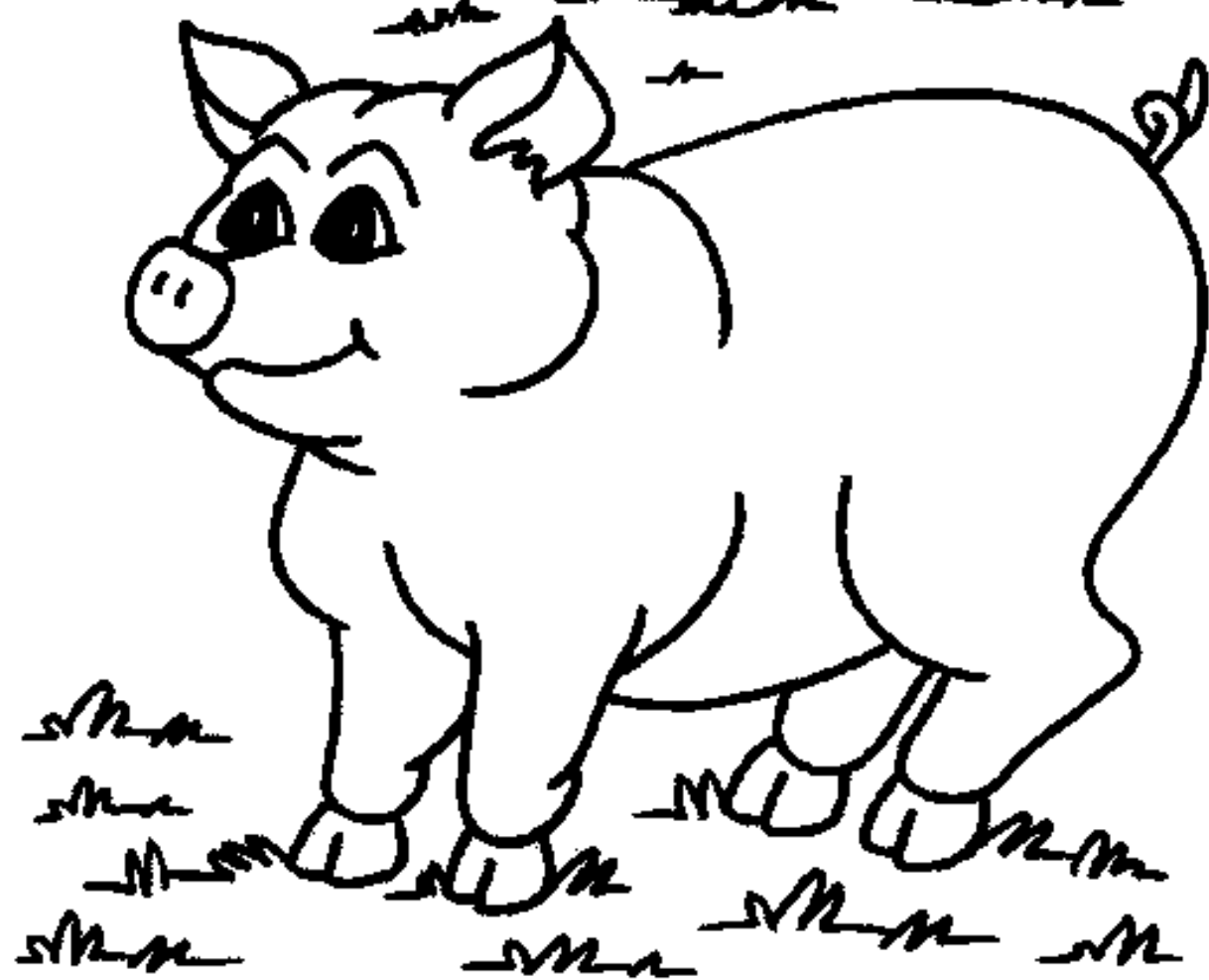
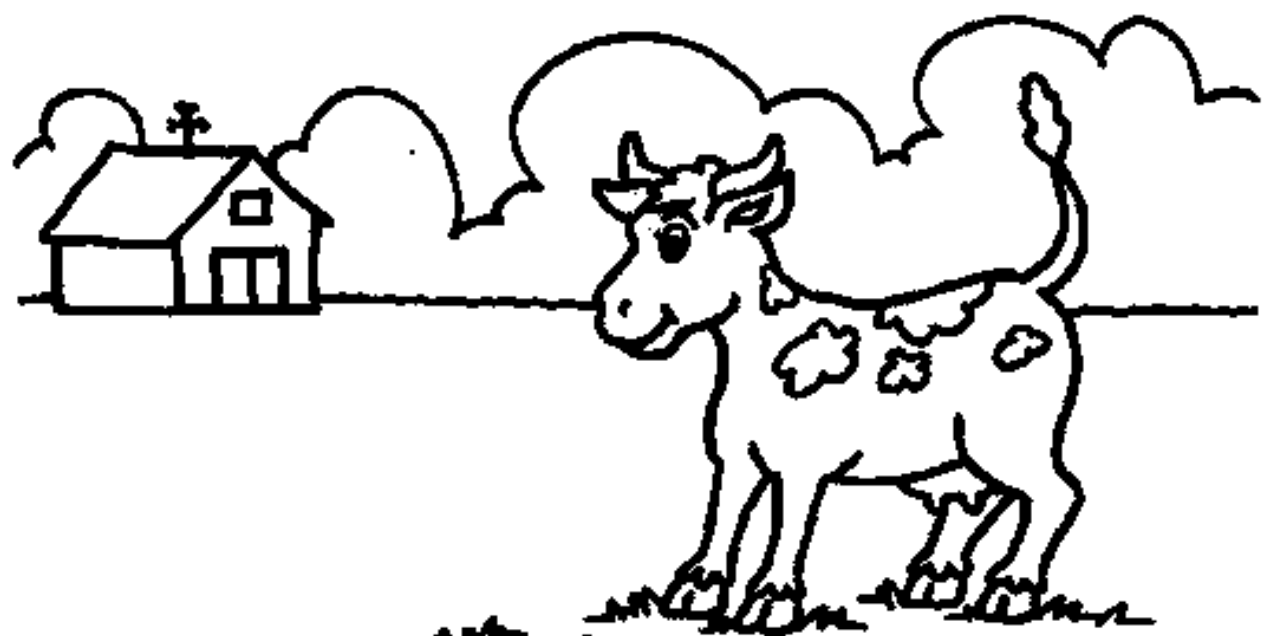



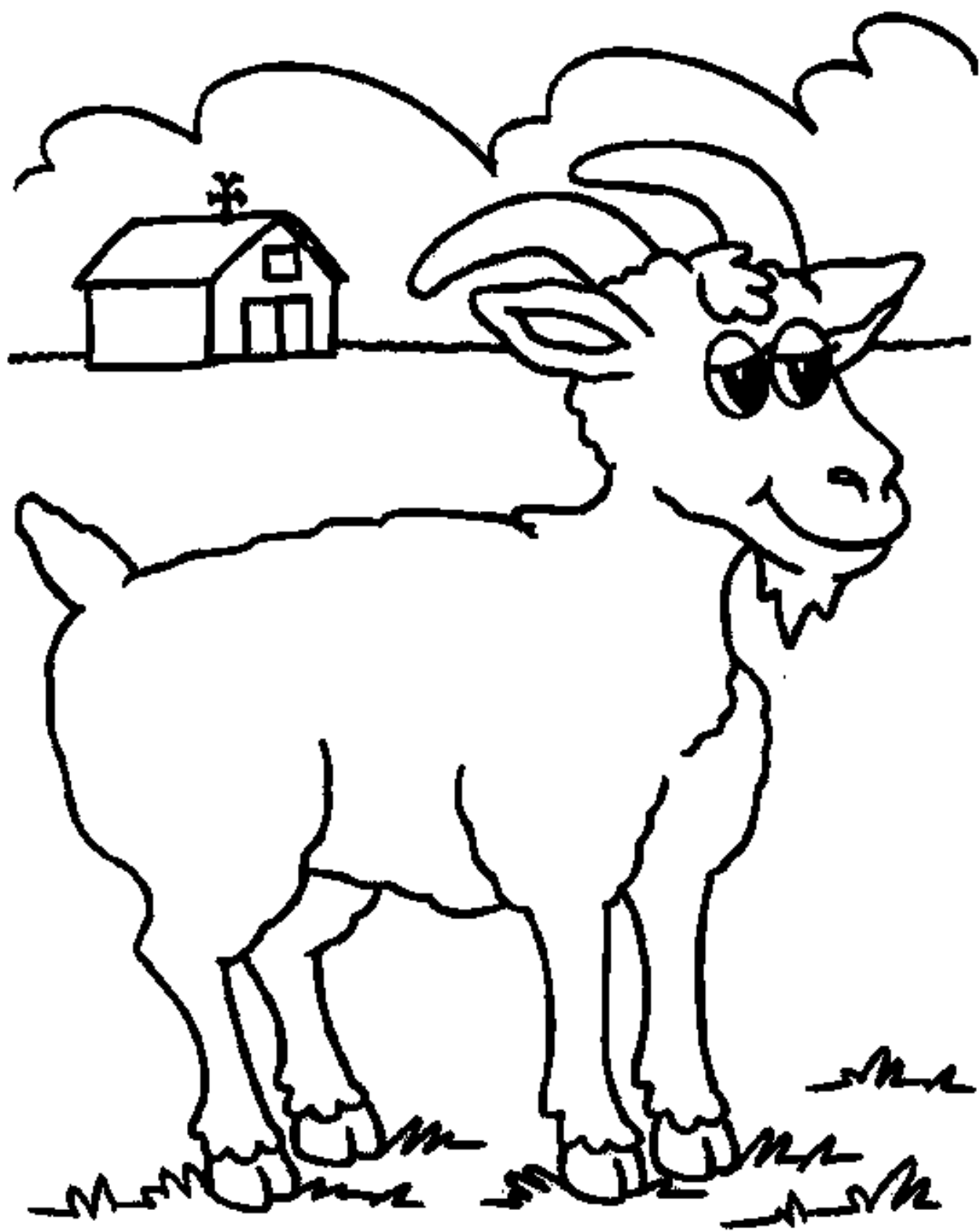

## What animals live on farms?

Some animals live on farms. Farm animals are helpful.



Cross out animals that are not farm animals.



Cut out the farm animals and  glue them in the pen.

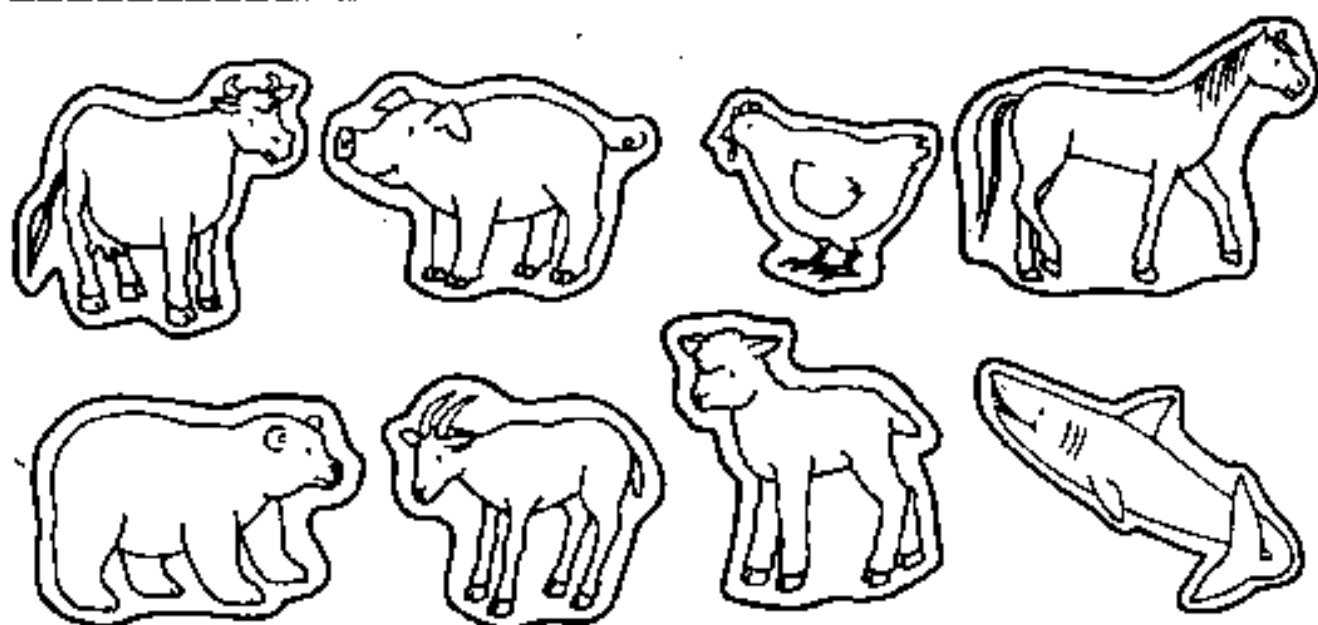
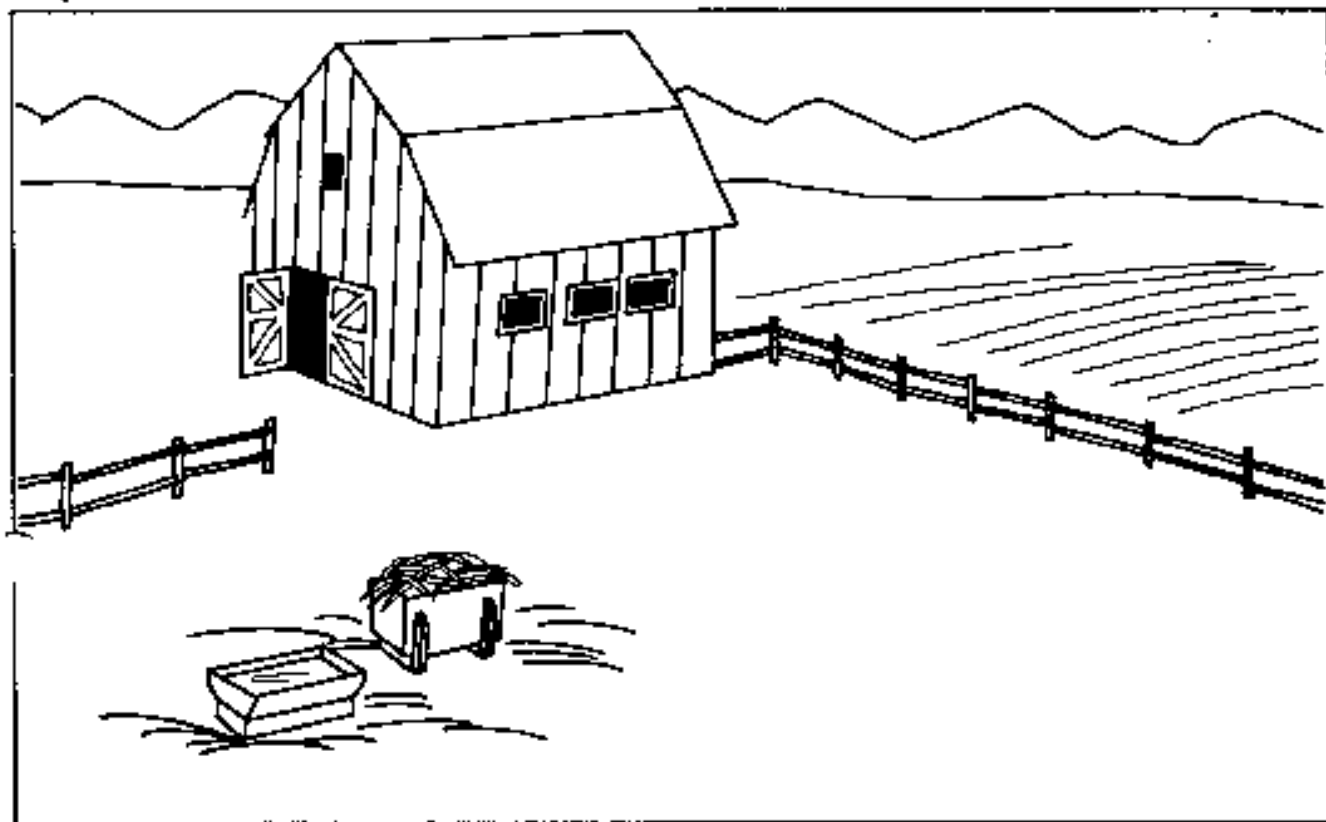

Which one doesn't belong?

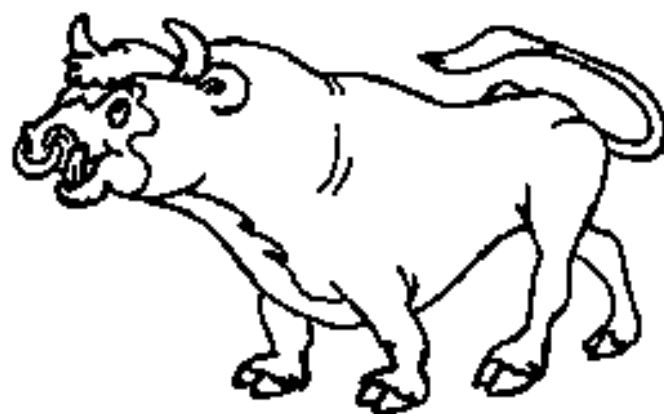
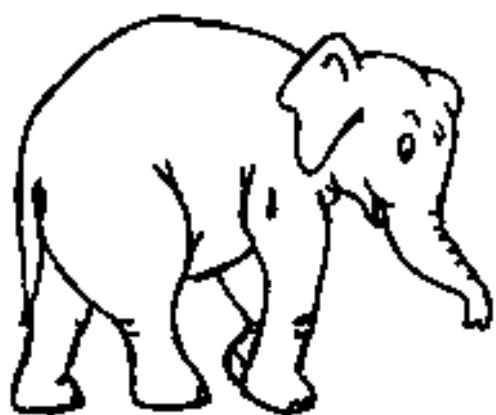
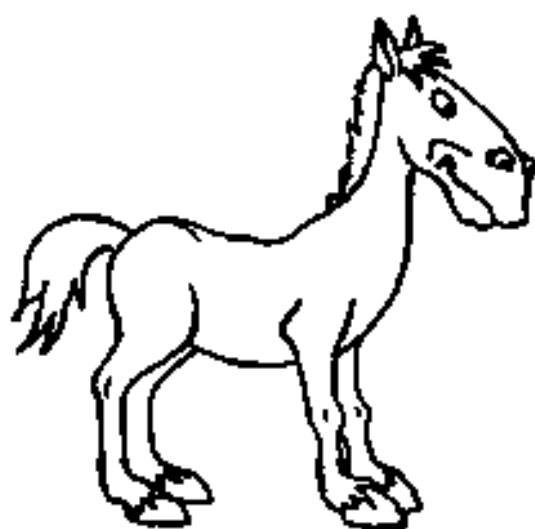

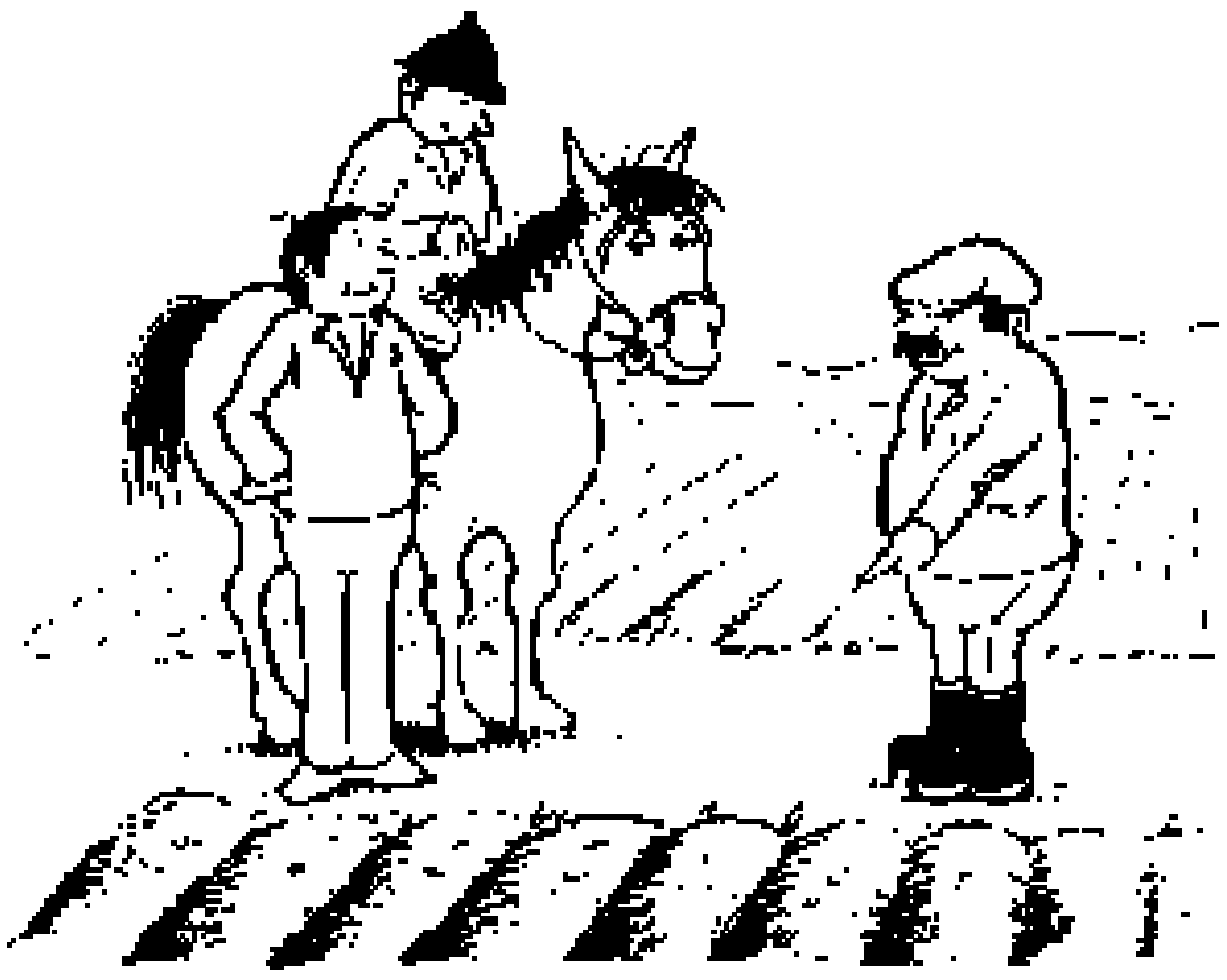



# shearing sheep

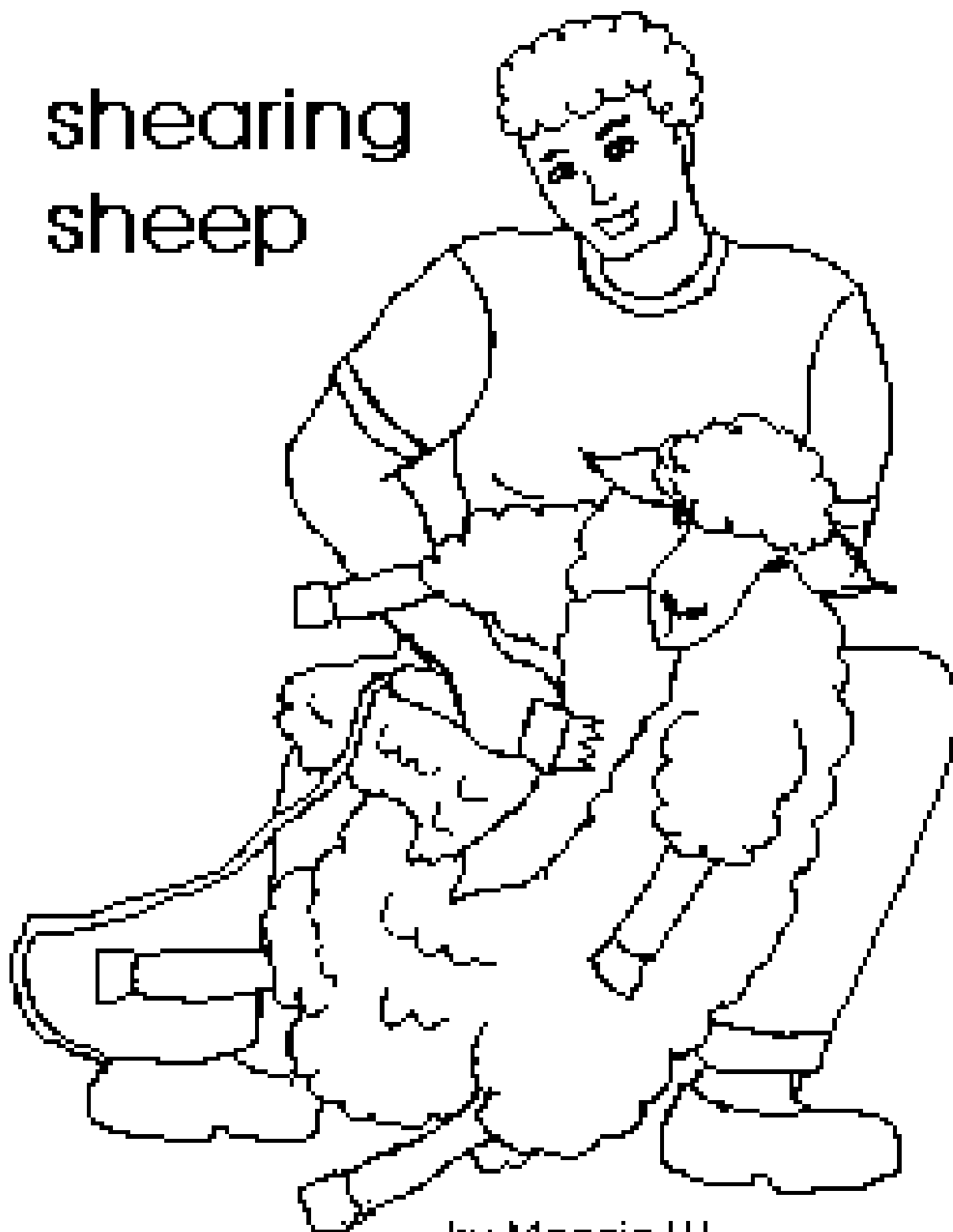

by Maggie LI

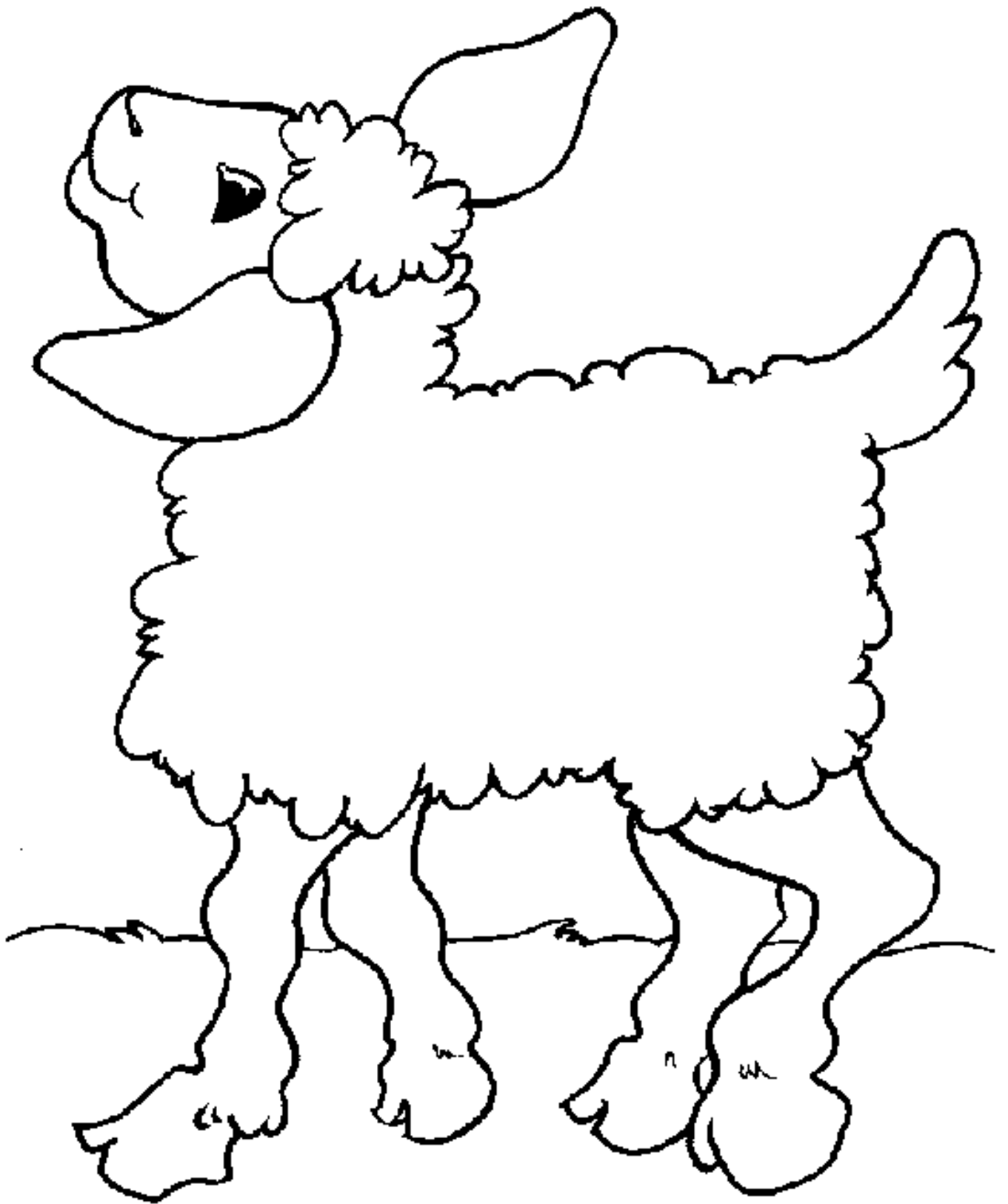

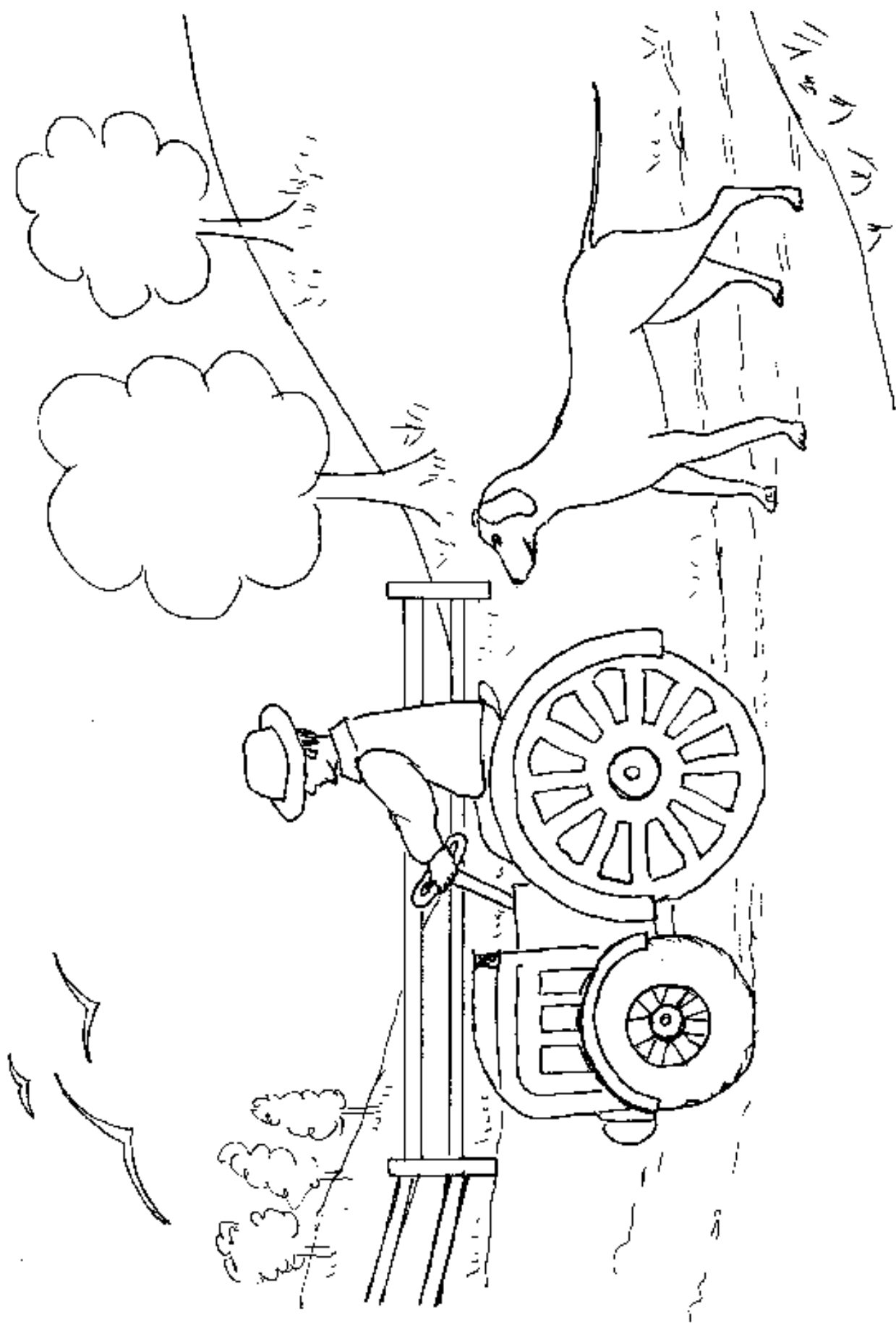



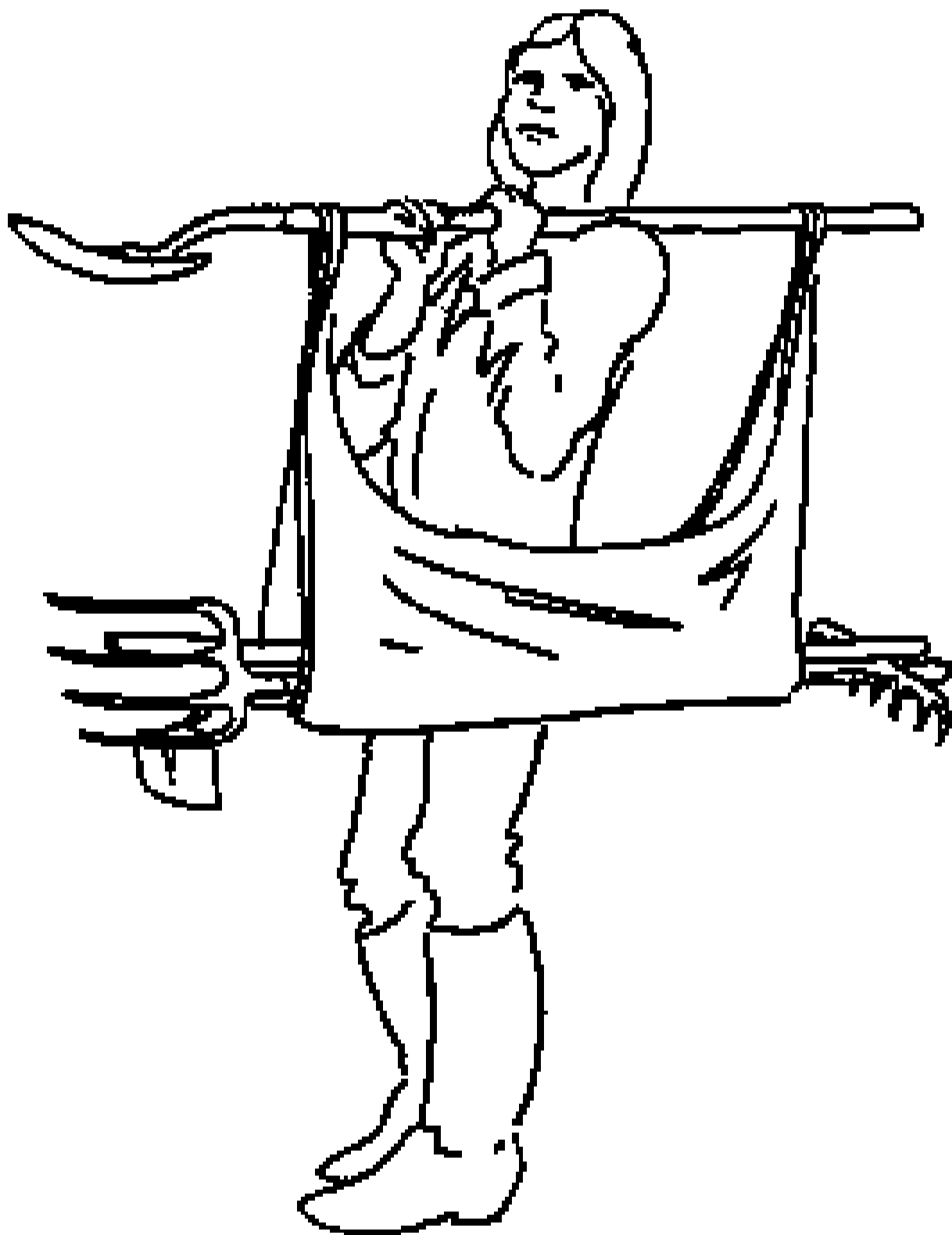

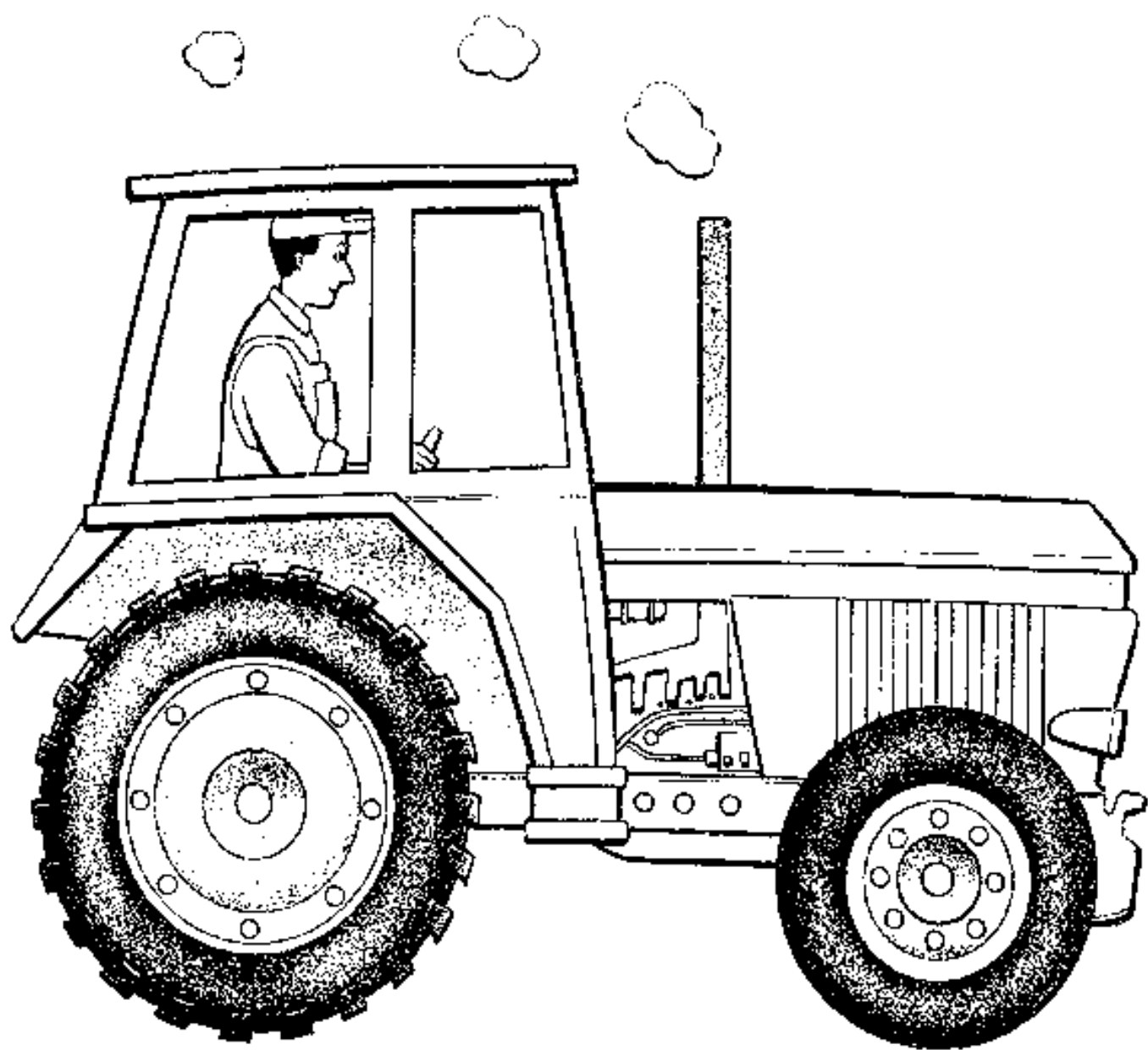

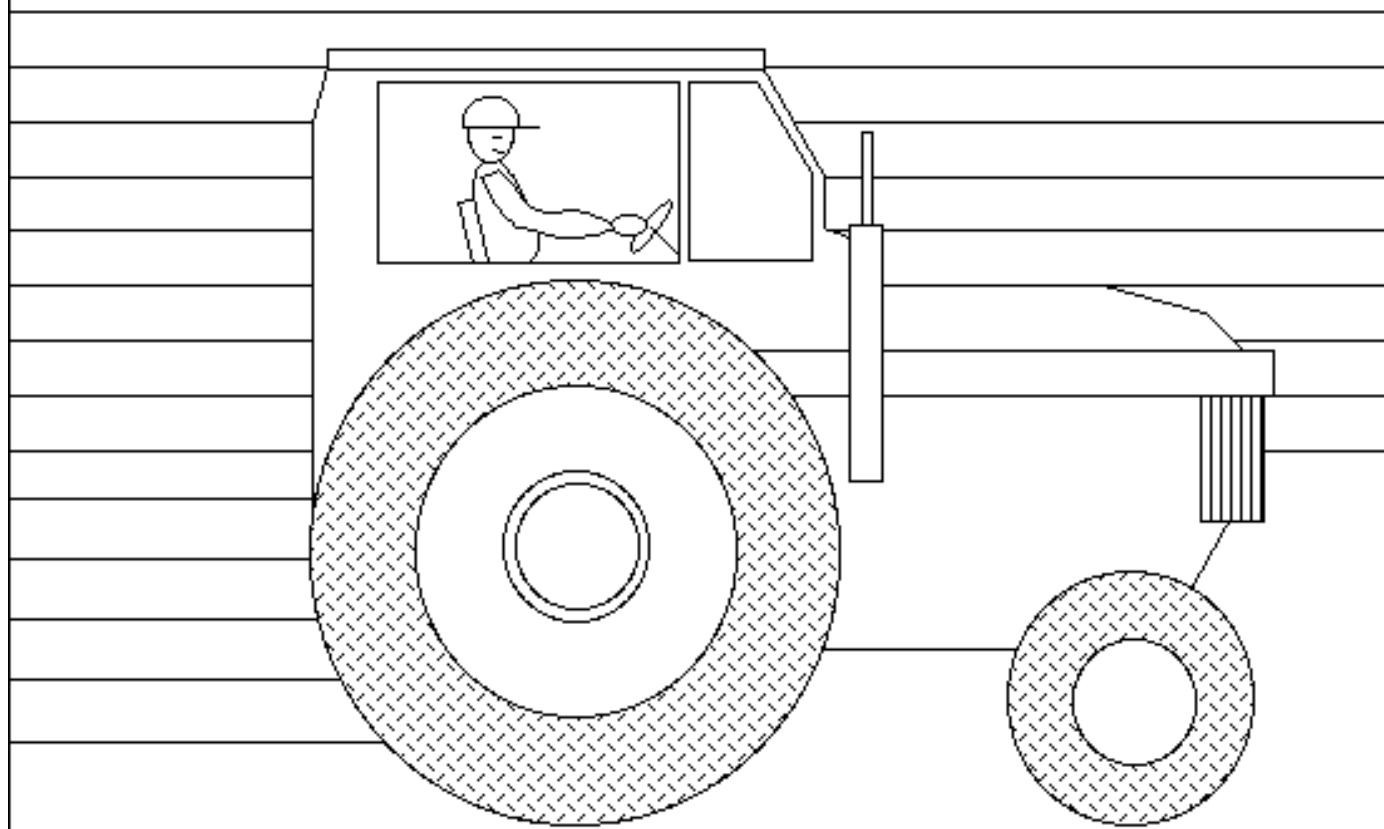
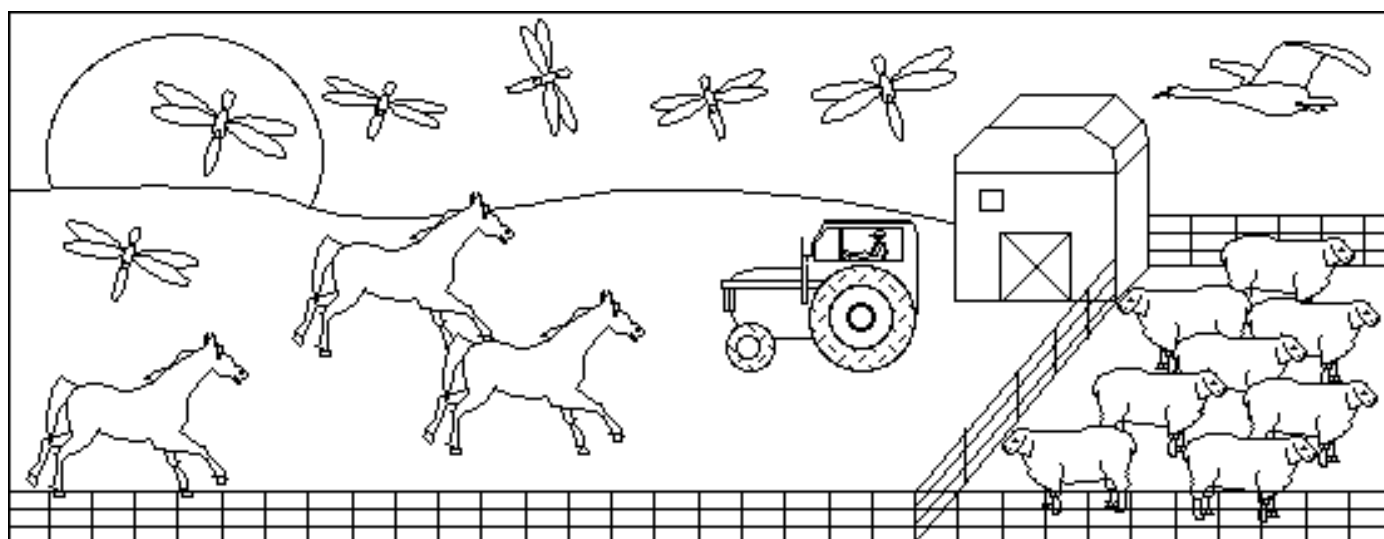

Tractor

